

FLIGHT RECORDERS

SANDY SELL.

NOVEMBER 2024

RECORDER MOCKUP

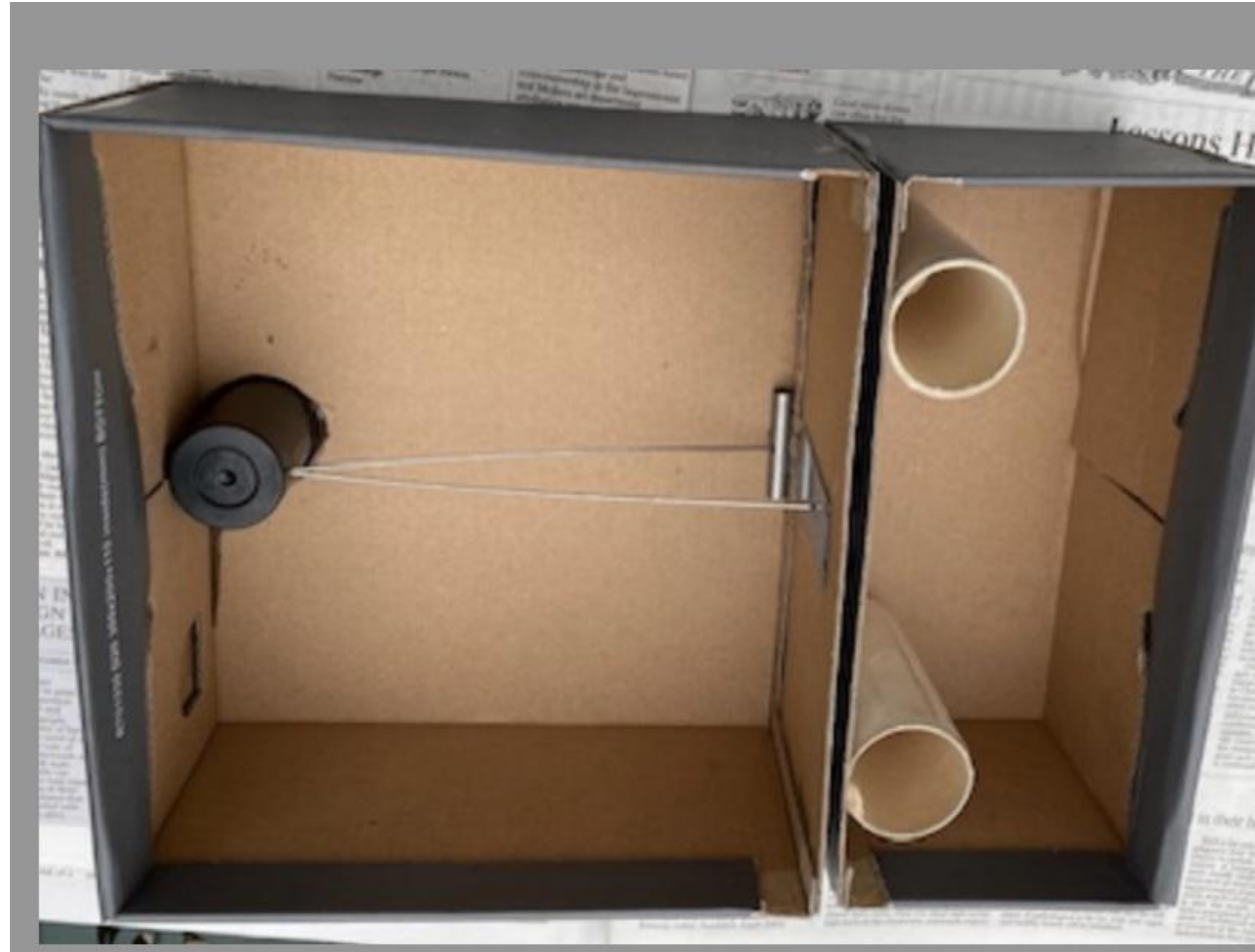

A Mechanical Altimeter

Static source



P_{Static}

Altitude Pointers



Expansion and contraction as a function of pressure difference



Capsules

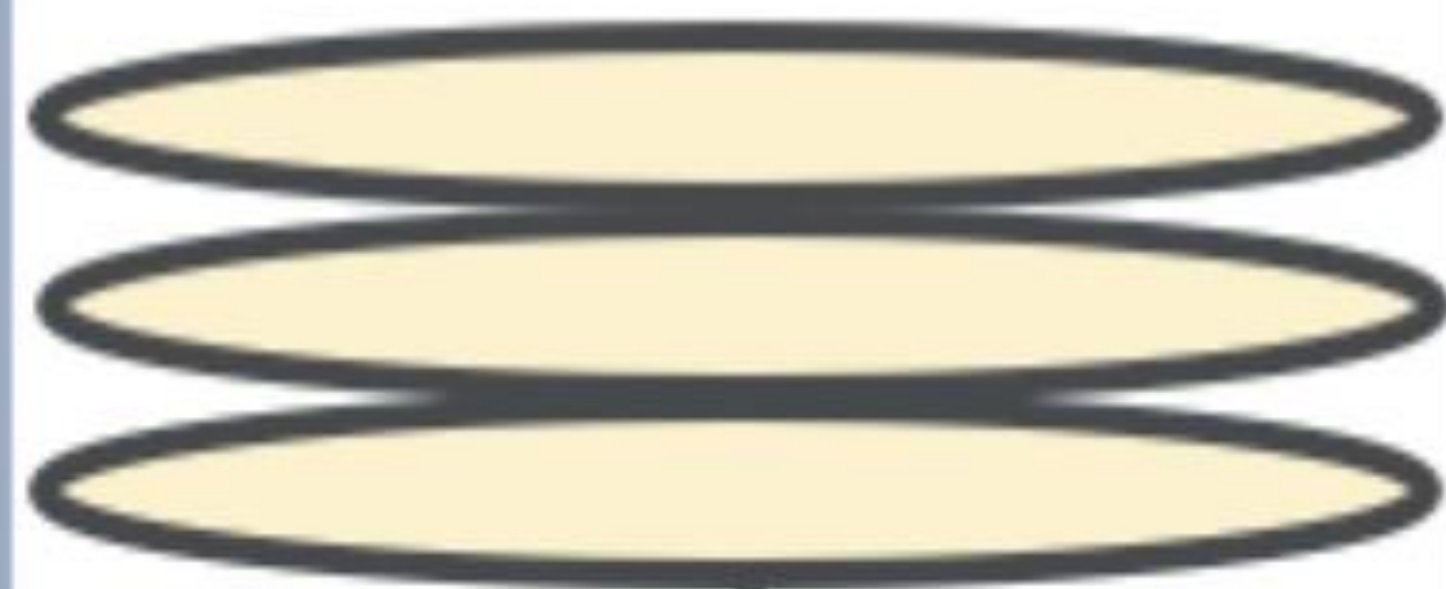

Setpoint adjustment



A Mechanical Airspeed Indicator

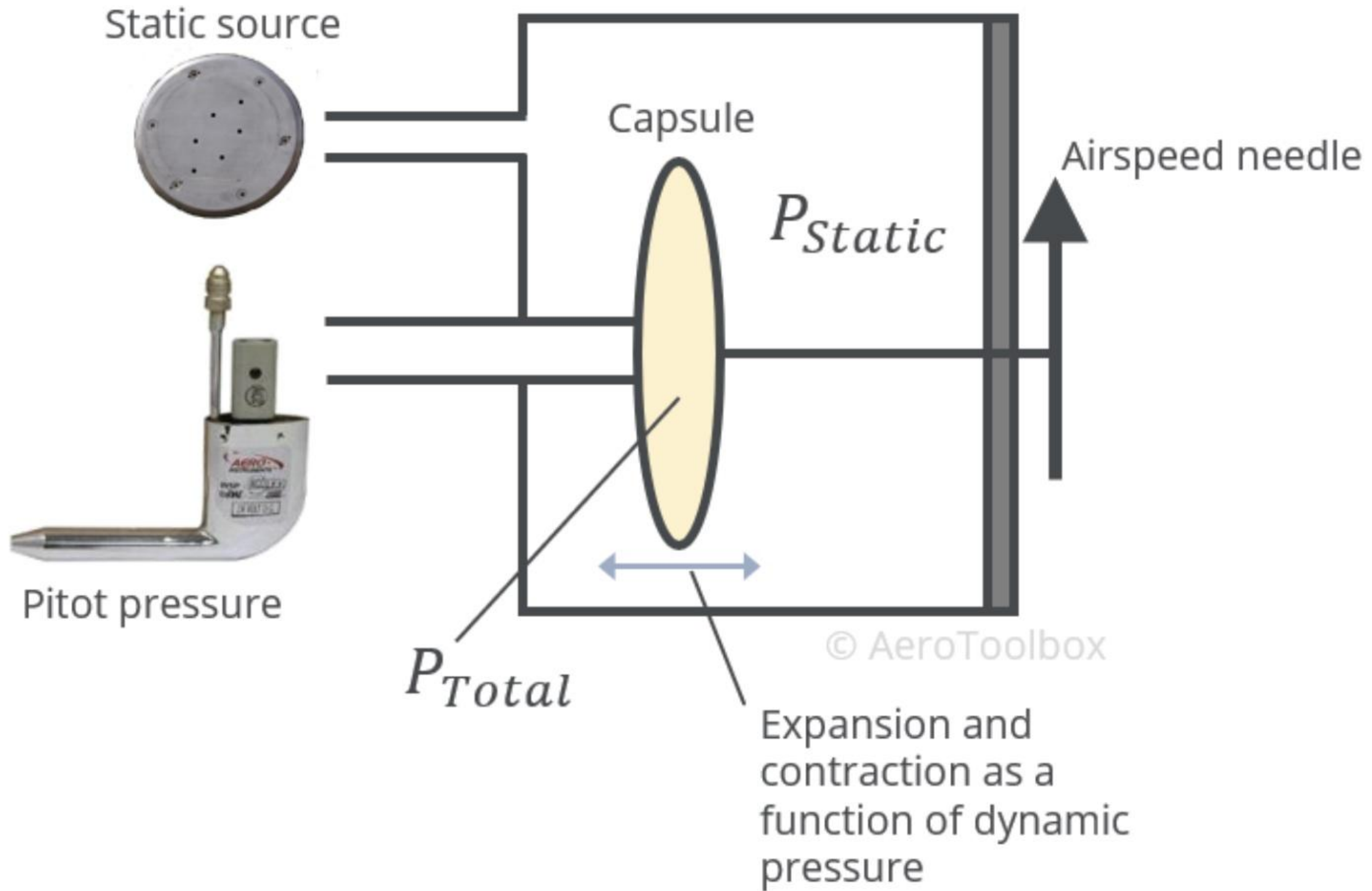

RATIOMETER

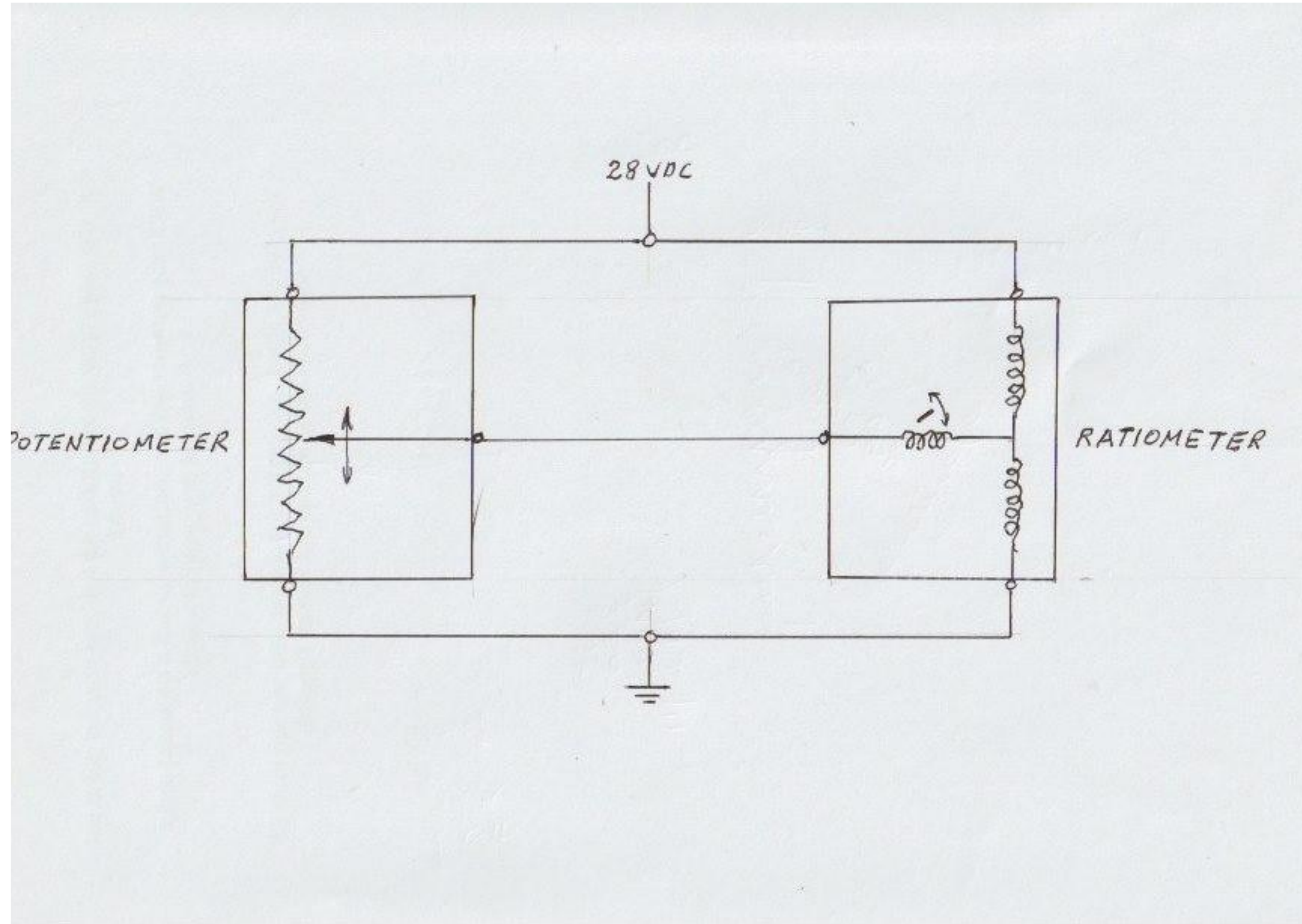

V G H PHOTOGRAPHIC RECORDER

- Fitted on two 707's
- V = airspeed
- A = altitude
- G = vertical g
measured at aircraft
centre of gravity

AIR REGISTRATION BOARD 707 CERTIFICATION

- Over rotation on take off
- Rudder authority
- Dave Davies, OBE

BOAC 707



CAADRP

- ARB review VGH films
- Contract with MOD
- 7 aircraft
- 18 channels

TYPICAL TRACE

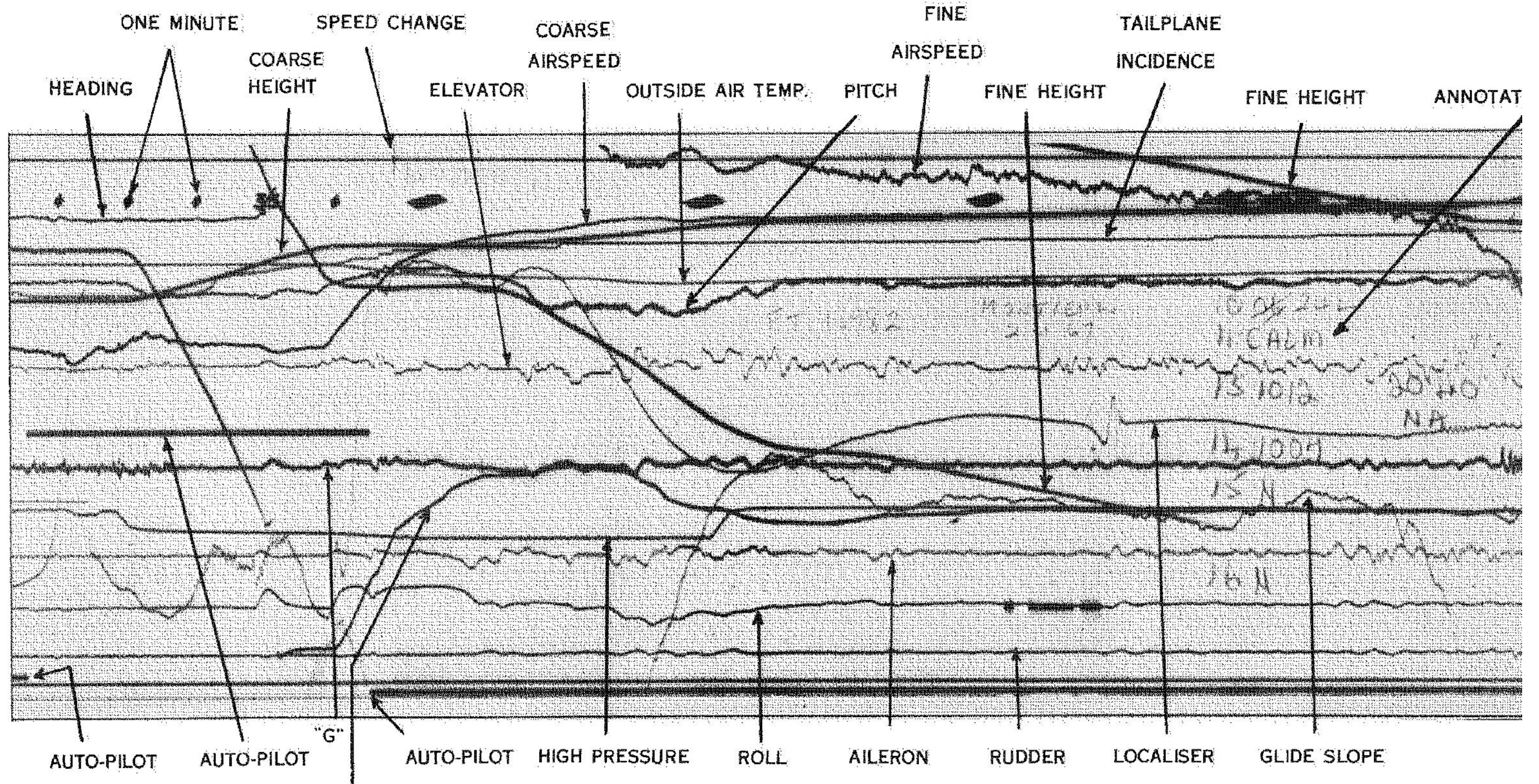

SPECIAL EVENTS

- Pod scrape
- Pressurisation failures
- Heavy landings
- Flap speeds
- Height lock instability
- OAT step change
- Blind landing
- G-APFE accident

MOUNT FUJI



MAIN WHEELS



SFIM RECORDER



BREAKUP SEQUENCE

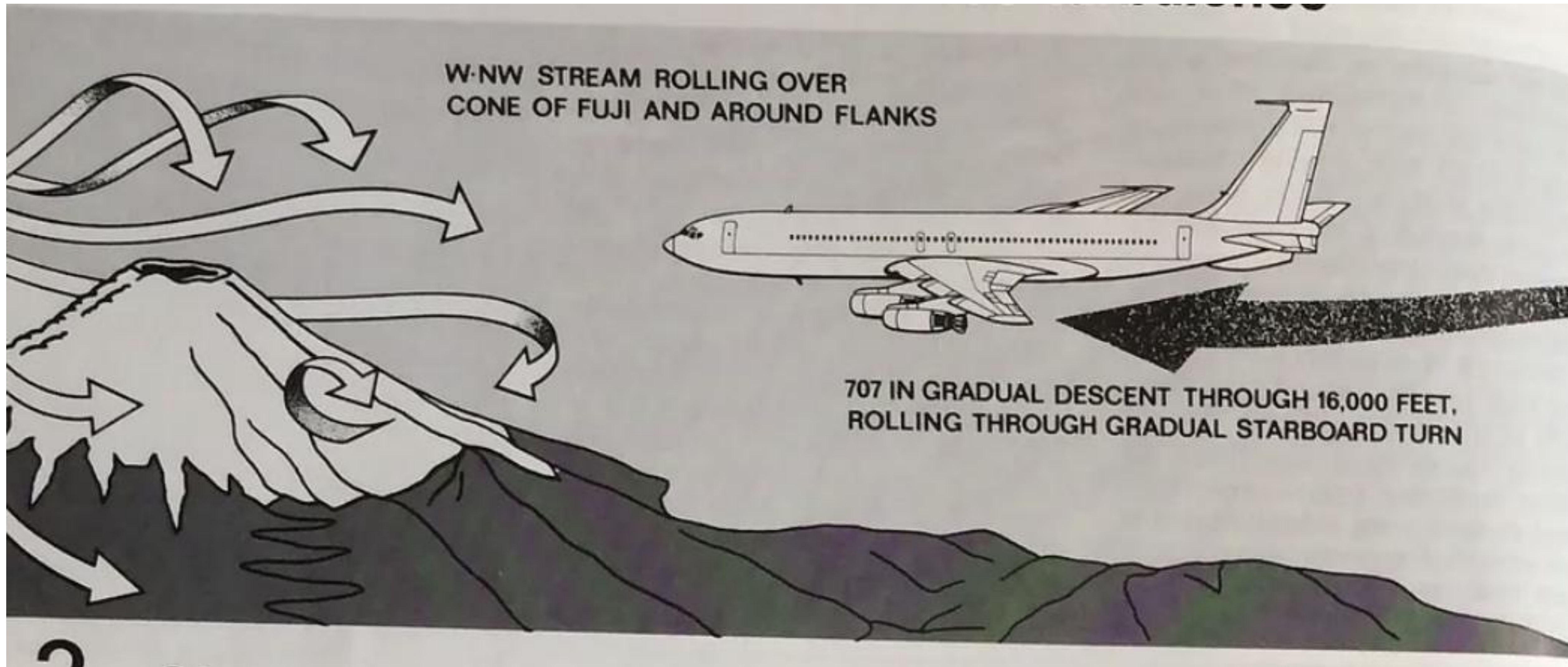

SIDEWAYS GUST

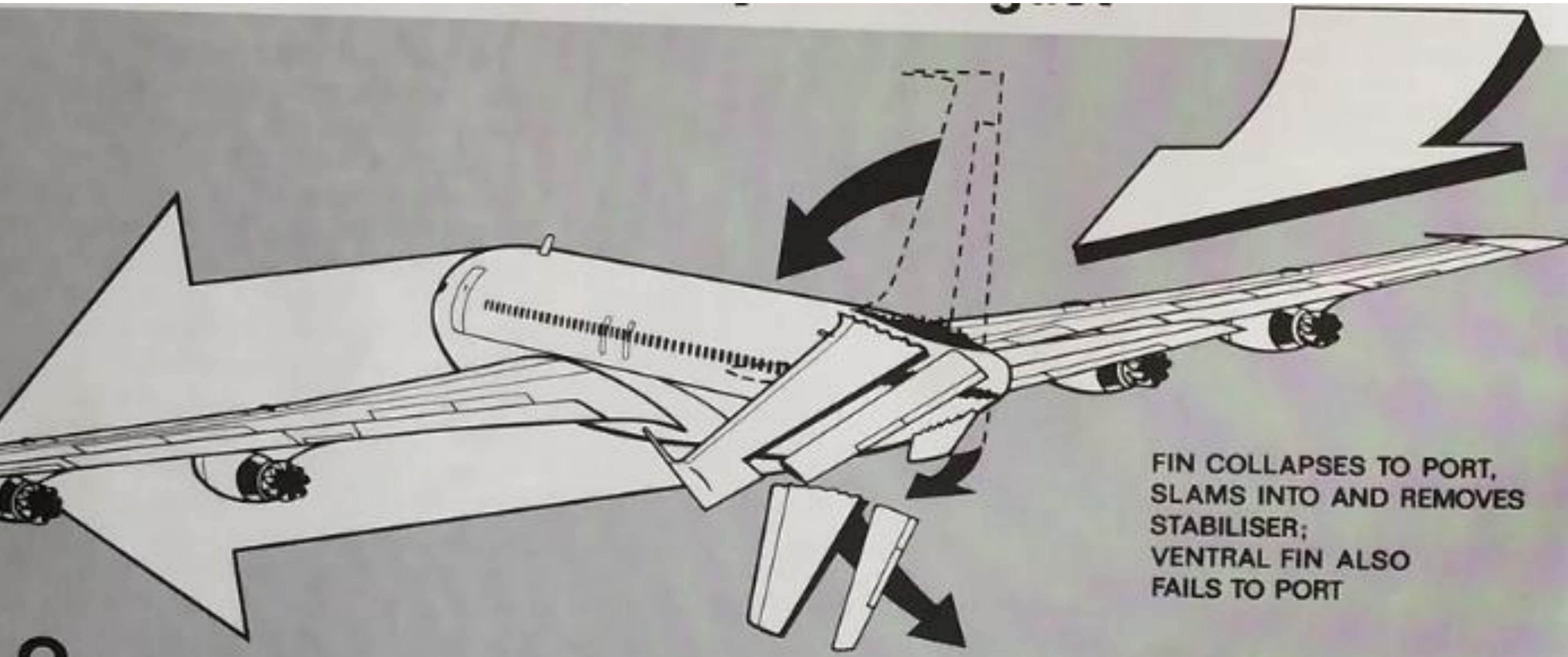

CONTINUED BREAKUP

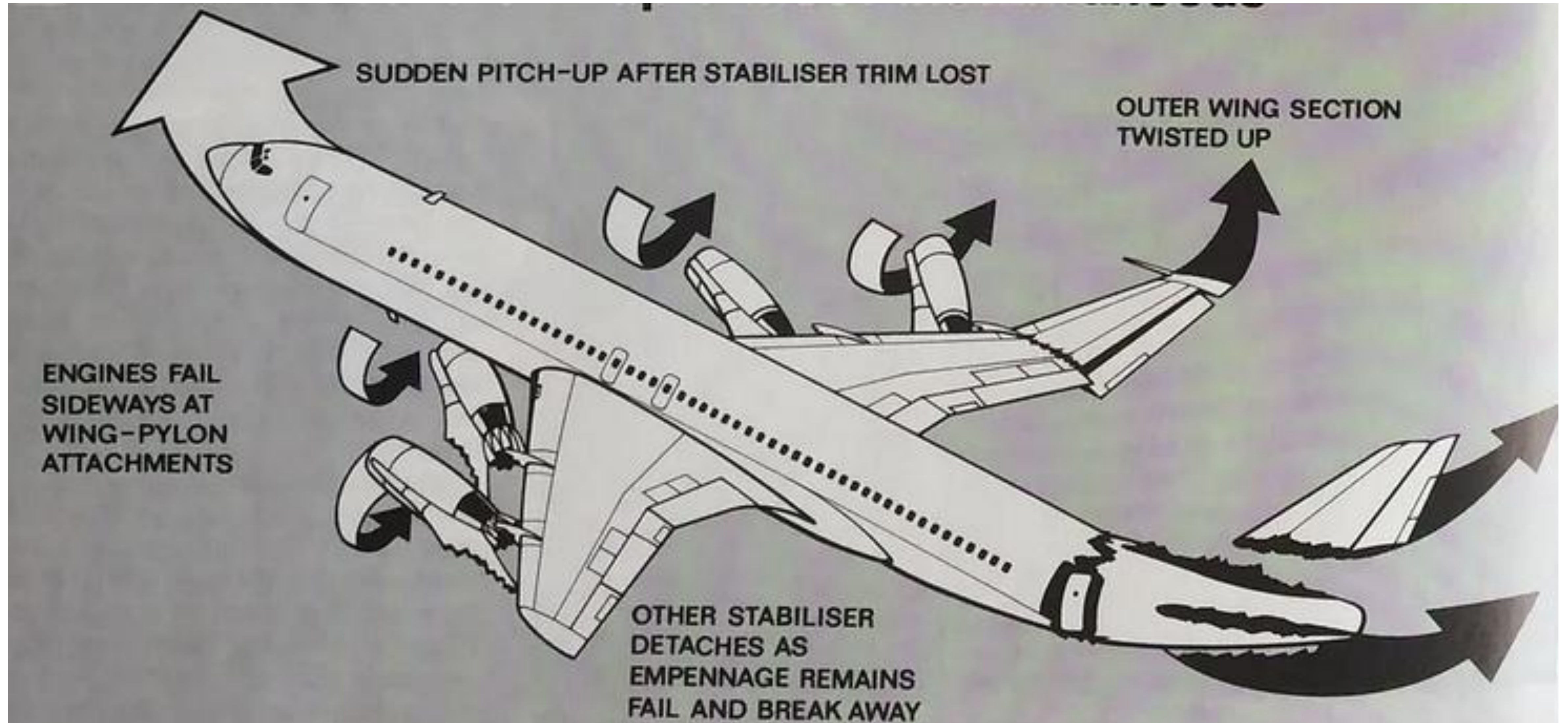

FLAT SPIN

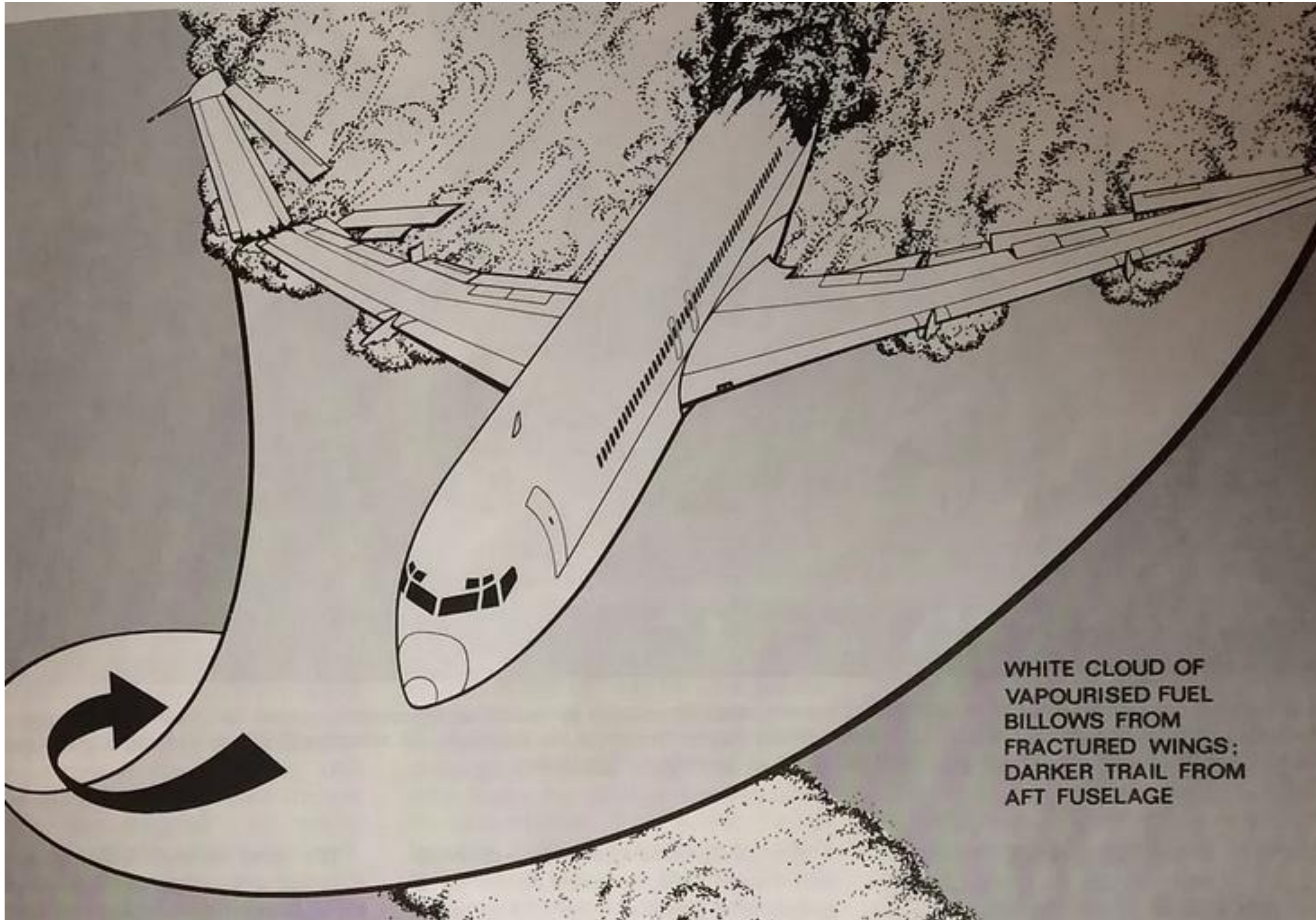

NOSE DETACHES

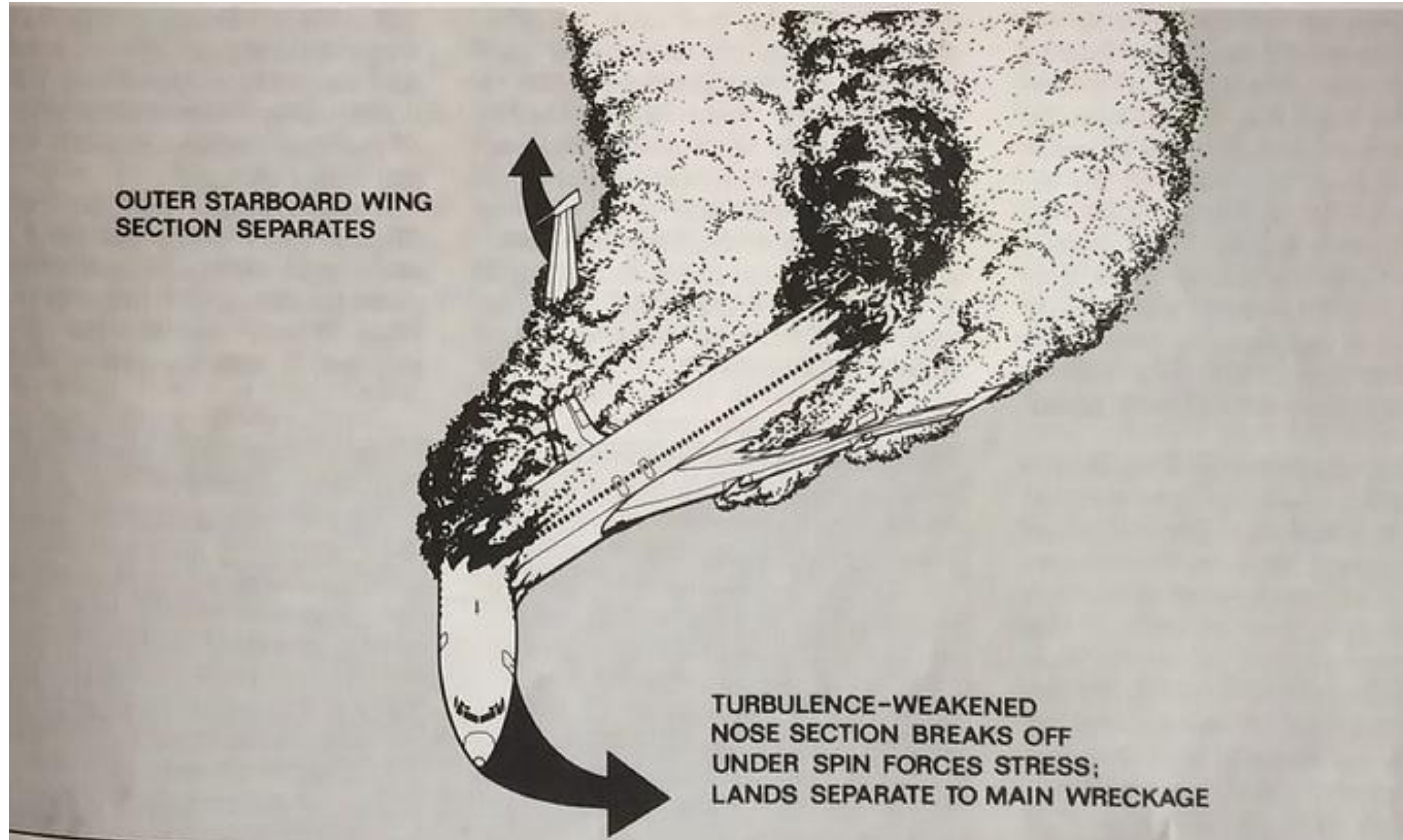

INVESTIGATION

- Wreckage
- Movie camera
- USAF
- Mountain waves

EARLY CRASH RECORDERS

- 1028 deaths in 1966
- Mandated in 1967
- BOAC, Penny & Giles
- BEA, Davall red egg
- USA scratch foil

DIGITAL ACCIDENT RECORDER

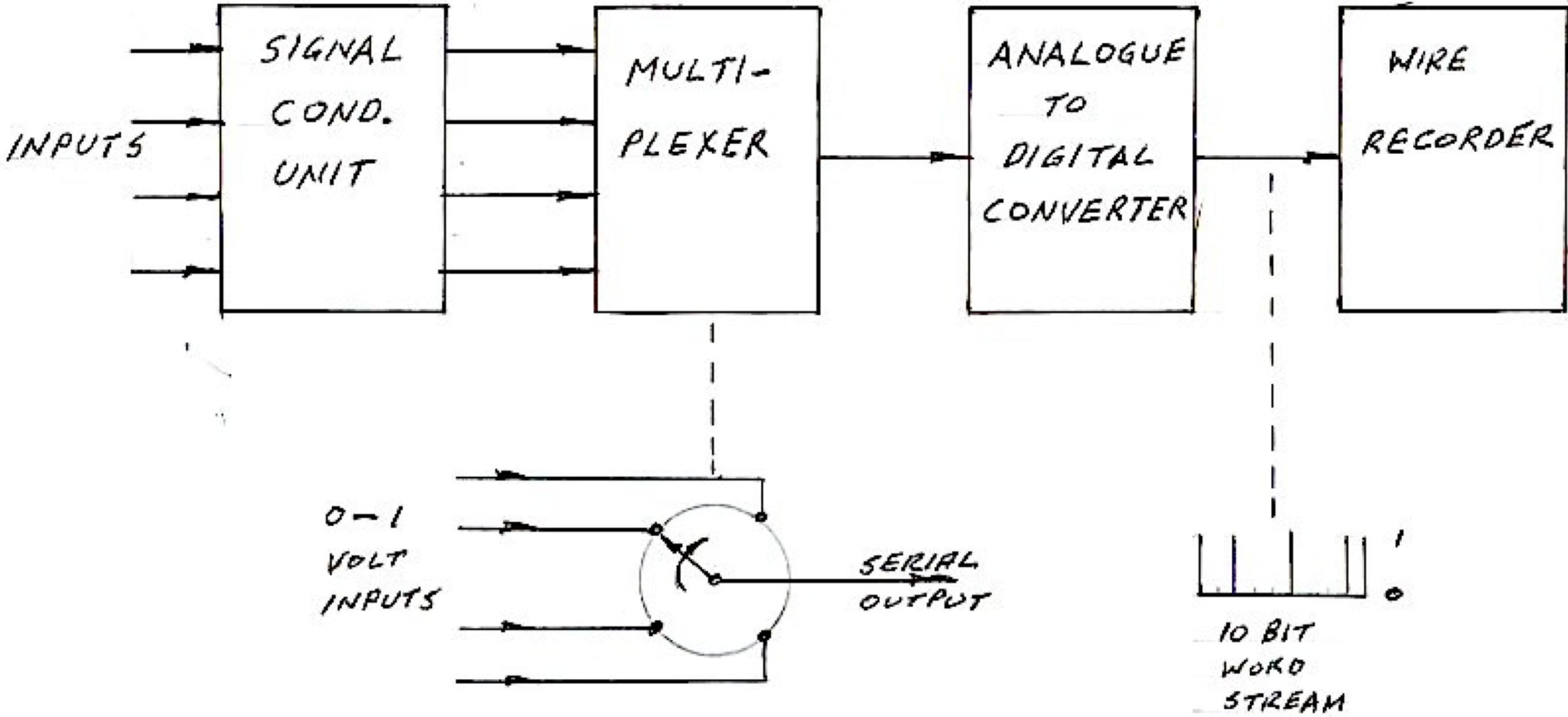

MODERN COMBINED RECORDER

